



Product Description

RFMD's SXA-3318B amplifier is a high efficiency GaAs Heterojunction Bipolar Transistor (HBT) MMIC housed in a low-cost surface-mountable plastic package. These HBT MMICs are fabricated using molecular beam epitaxial growth technology which produces reliable and consistent performance from wafer to wafer and lot to lot. These amplifiers are specially designed for use as driver devices for infrastructure equipment in the 400-2500 MHz cellular, ISM, WLL, PCS, W-CDMA applications. Its high linearity makes it an ideal choice for multi-carrier as well as digital applications.

Optimum Technology Matching® Applied

- GaAs HBT
- GaAs MESFET
- InGaP HBT
- SiGe BiCMOS
- Si BiCMOS
- SiGe HBT
- GaAs pHEMT
- Si CMOS
- Si BJT
- GaN HEMT
- RF MEMS

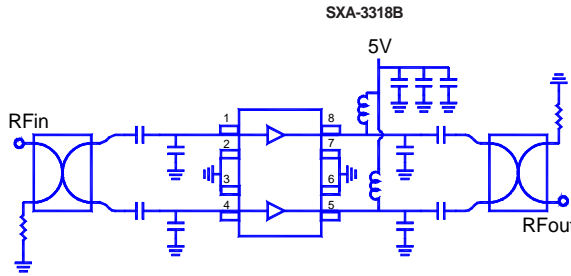

Features

- On-Chip Active Bias Control
- Balanced For Excellent Input/Output VSWR and Minimized Reflections
- High OIP₃ : +47 dBm Typ.
- High P_{1dB} : +28 dBm Typ.
- Patented High Reliability GaAs HBT Technology
- Surface-Mountable Power Plastic Package

Applications

- W-CDMA, PCS, Cellular Systems
- High Linearity IF Amplifiers
- Multi-Carrier Applications

Parameter	Specification			Unit	Condition
	Min.	Typ.	Max.		
Small Signal Gain	16.0	17.5	19.0	dB	850MHz
		12.8		dB	1960MHz
		10.5	13.5	dB	2140MHz
Output Power at 1dB Compression		27.5		dBm	850MHz
		28.0		dBm	1960MHz
		27.0	28.0	dBm	2140MHz
Output Third Order Intercept Point	44.0	47.0		dBm	850MHz, P _{OUT} per tone = +11dBm, Tone Spacing = 1MHz
		47.0		dBm	1960MHz
		44.0	47.0	dBm	2140MHz
Noise Figure		4.5	6.0	dB	850MHz
		5.1		dB	1960MHz and 2140MHz
Input VSWR		1.3	1.7		850MHz
		1.2			1960MHz and 2140MHz
Adjacent Channel Power		-55.0		dBc	880MHz and 1960MHz, IS-95 at P _{OUT} = 19dBm
		-50		dBc	2140MHz, W-CDMA at P _{OUT} = 18dBm
Device Operating Current	180.0	240.0	280.0	mA	V _{CC} = 5V, 120mA per amplifier
Thermal Resistance		70		°C/W	junction to backside (2 amplifiers per packaged part)

Test Conditions: Z₀ = 50Ω, T_A = 25°C, Measured in Evaluation Circuit

Absolute Maximum Ratings

Parameter	Rating	Unit
Max Device Current (I_D) - Per amplifier, 2 amplifiers per packaged part	240	mA
Max Device Voltage (V_{CC})	6	V
Max RF Input Power	100	mW
Max Dissipated Power	1500	mW
Max Junction Temperature (T_J)	160	°C
Operating Temperature Range (T_L)	-40 to + 85	°C
Max Storage Temperature	150	°C
ESD Rating - Human Body Model (HBM)	Class 1B	
Moisture Sensitivity Level	MSL 1	



Caution! ESD sensitive device.

Exceeding any one or a combination of the Absolute Maximum Rating conditions may cause permanent damage to the device. Extended application of Absolute Maximum Rating conditions to the device may reduce device reliability. Specified typical performance or functional operation of the device under Absolute Maximum Rating conditions is not implied.

RoHS status based on EU Directive 2002/95/EC (at time of this document revision).

The information in this publication is believed to be accurate and reliable. However, no responsibility is assumed by RF Micro Devices, Inc. ("RFMD") for its use, nor for any infringement of patents, or other rights of third parties, resulting from its use. No license is granted by implication or otherwise under any patent or patent rights of RFMD. RFMD reserves the right to change component circuitry, recommended application circuitry and specifications at any time without prior notice.

Operation of this device beyond any one of these limits may cause permanent damage. For reliable continuous operation, the device voltage and current must not exceed the maximum operating values specified in the table on page one.

Bias Conditions should also satisfy the following expression:

$$I_D V_D < (T_J - T_L) / R_{TH, J-L}$$

Device Current vs. Source Voltage

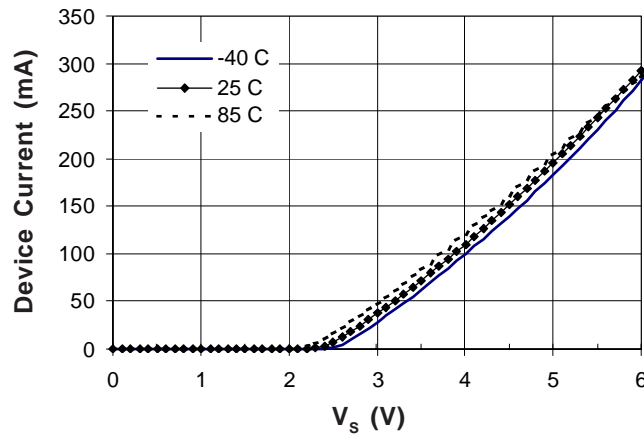

850MHz Application Circuit Data, VCC=5V, ID=240mA (Tested in Balanced Configuration shown in Application Circuit, tuned for Output 1P3)

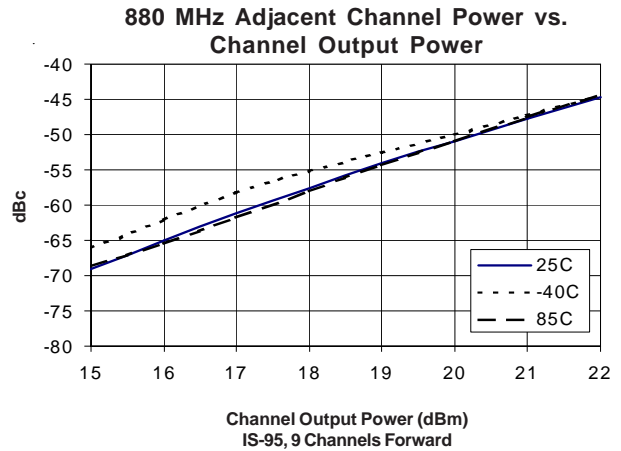
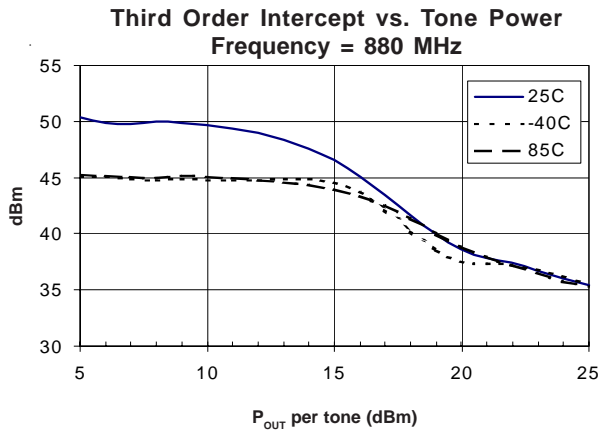
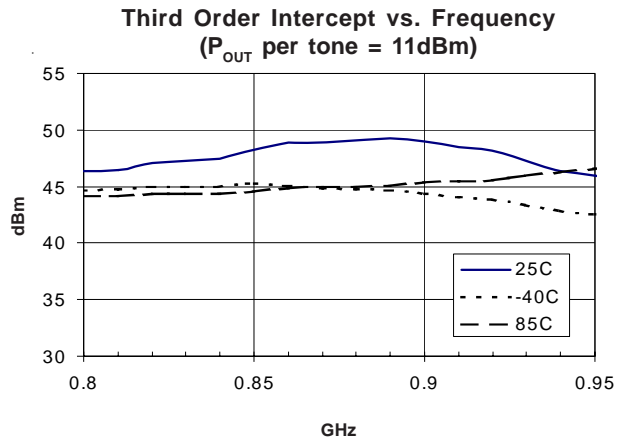
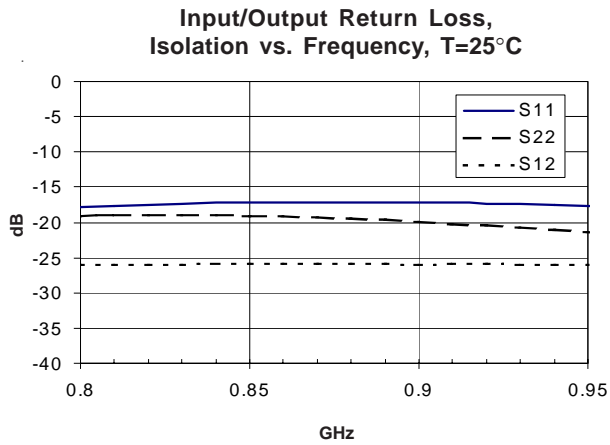
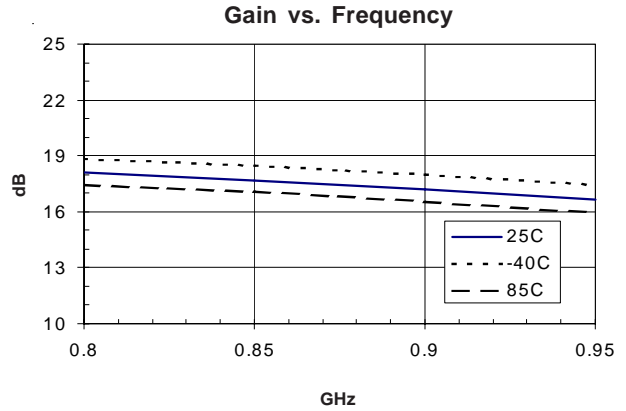
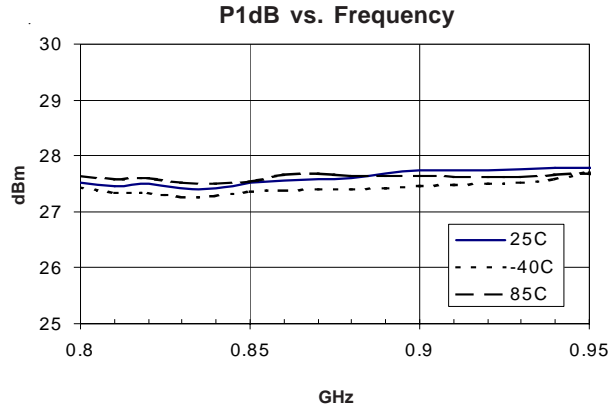

1960MHz Application Circuit Data, VCC=5V, ID=240mA (Tested in Balanced Configuration shown in Application Circuit, tuned for Output 1P3)

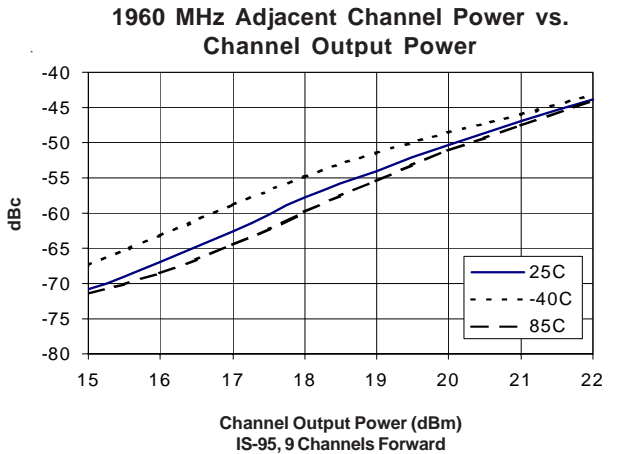
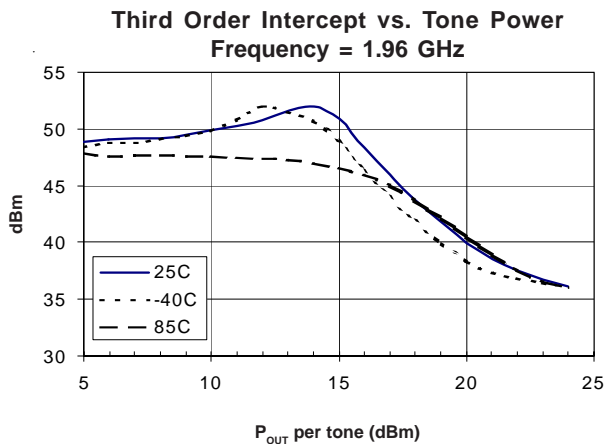
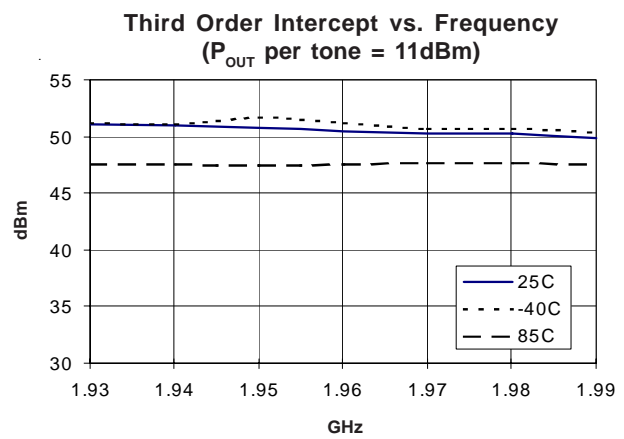
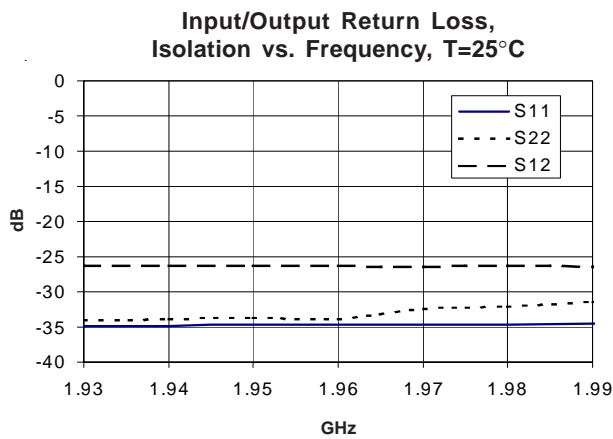
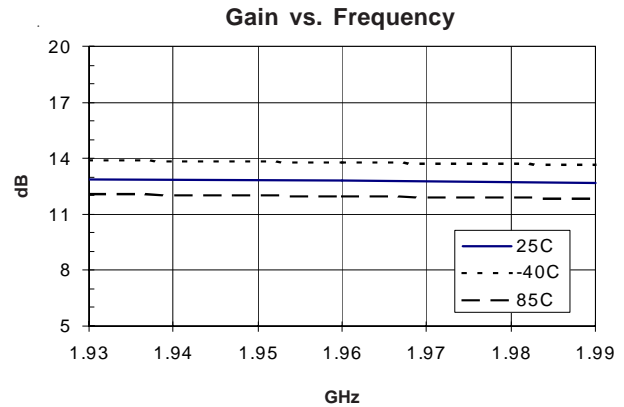
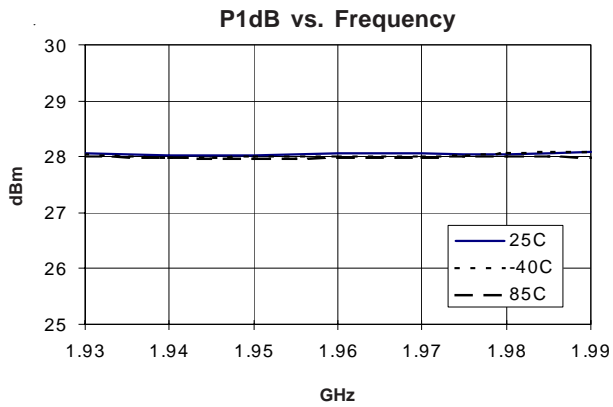

2140MHz Application Circuit Data, VCC=5V, ID=240mA (Tested in Balanced Configuration shown in Application Circuit, tuned for Output 1P3)

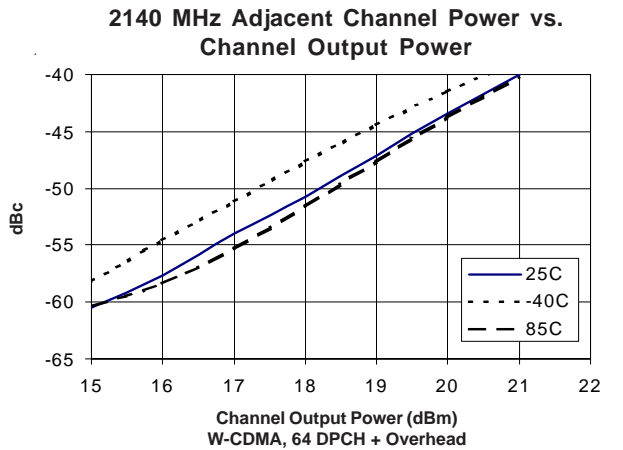
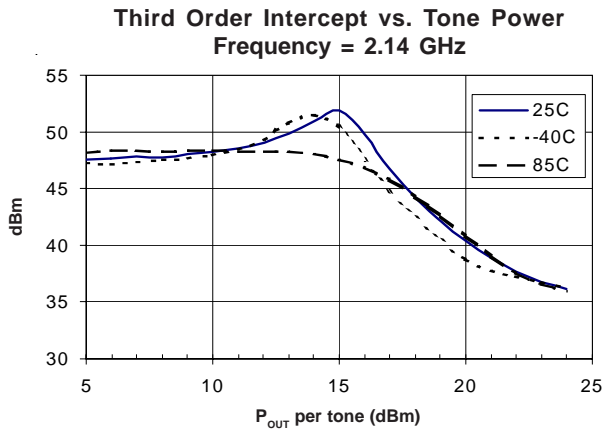
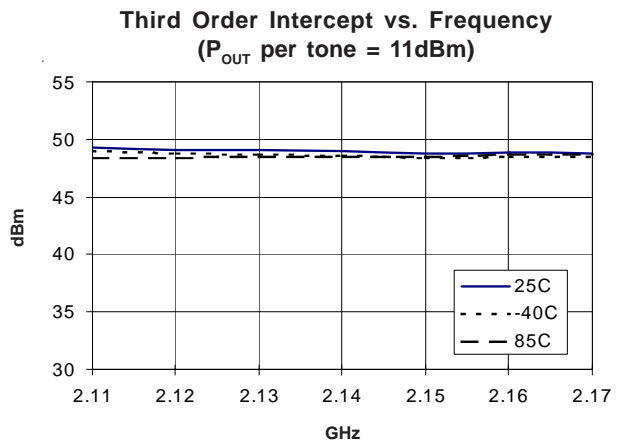
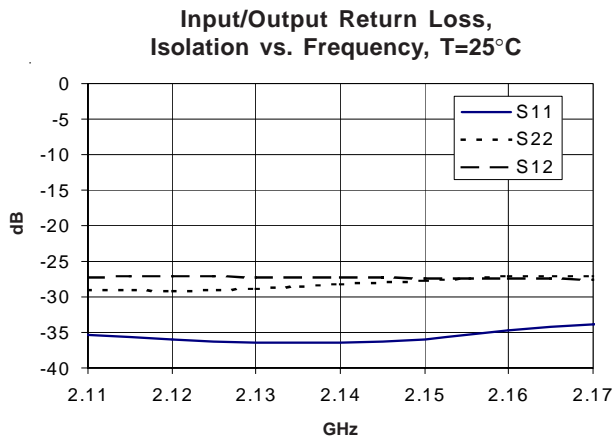
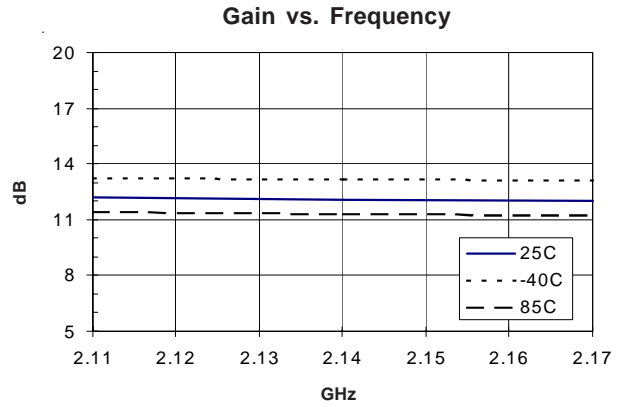
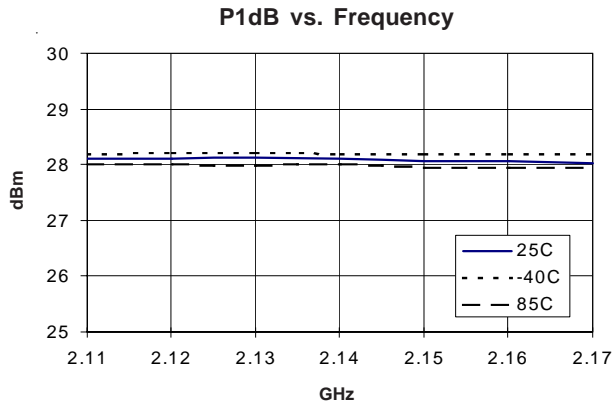

Pin	Function	Description
1, 4	RF IN	RF input pin. This pin requires the use of an external DC blocking capacitor.
2, 3, 6, 7	GND	Use via holes to reduce connection to ground. Place vias close to ground lead inductance.
5, 8	RF OUT/VCC	RF output and bias pin. Bias should be supplied to this pin through an external RF choke. Because DC biasing is present on this pin, a DC blocking capacitor should be used in most applications. The supply side of the bias network should be well bypassed. An output matching network is necessary for optimum performance.
EPAD	GND	Exposed area on the bottom side of the package needs to be soldered to the ground plane of the board for thermal and RF performance. Several vias should be located under the EPAD.

Recommended Land Pattern

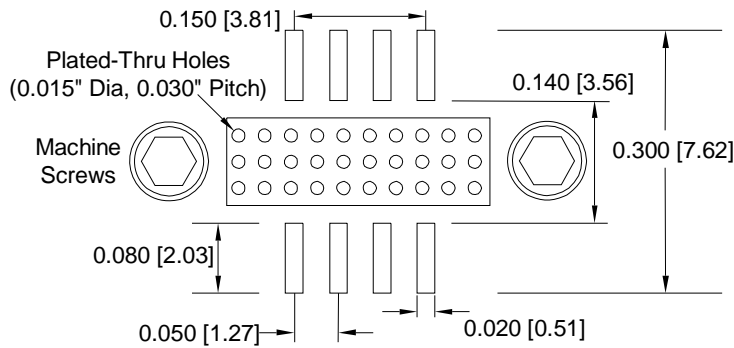

Package Drawing

Dimensions in inches (millimeters)

Refer to drawing posted at www.rfmd.com for tolerances.

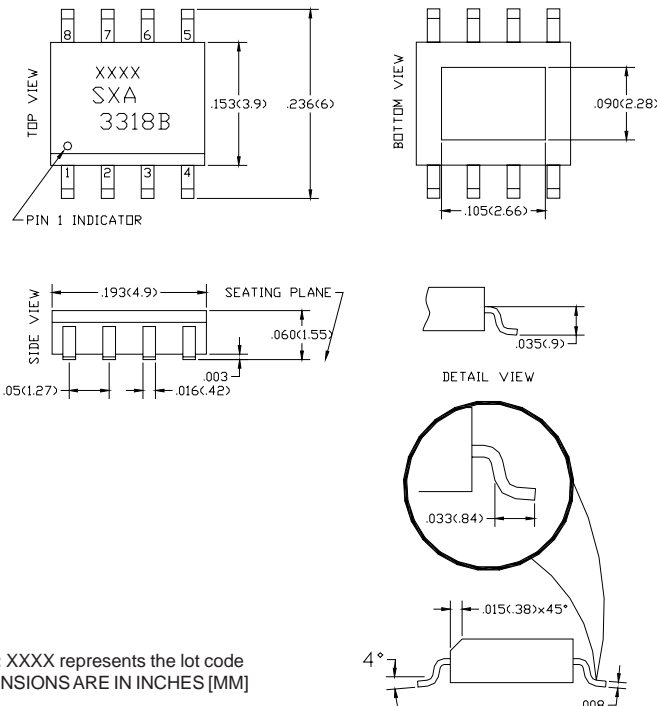

NOT

850 MHz Application Schematic

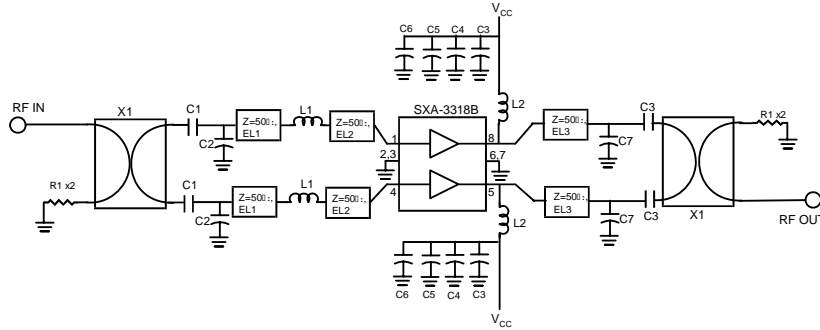

Ref. Des.	Vendor Series	850 MHz
C1, C3	Rohm MCH18	47pF, 5%
C2	Rohm MCH18	3.9pF, ± 0.25 pF
C4	Rohm MCH18	1000pF, 5%
C5	Rohm TAJB104KLRH	0.1uF, 10%
C6	Rohm TAJB106K020R	10uF, 10%
C7	Rohm MCH18	3.3pF, ± 0.25 pF
L1	Toko LL1608-FS	1.2nH, ± 0.3 nH

Ref. Des.	Vendor Series	850 MHz
L2	Toko LL1608-FS	33nH, 5%
EL1	50 Ohms	9.9°
EL2	50 Ohms	4.4°
EL3	50 Ohms	11°
X1	Sirenza Coupler	AH03L
R1	Rohm MCR100J	100 Ohm, 5%

850 MHz Evaluation Board Layout

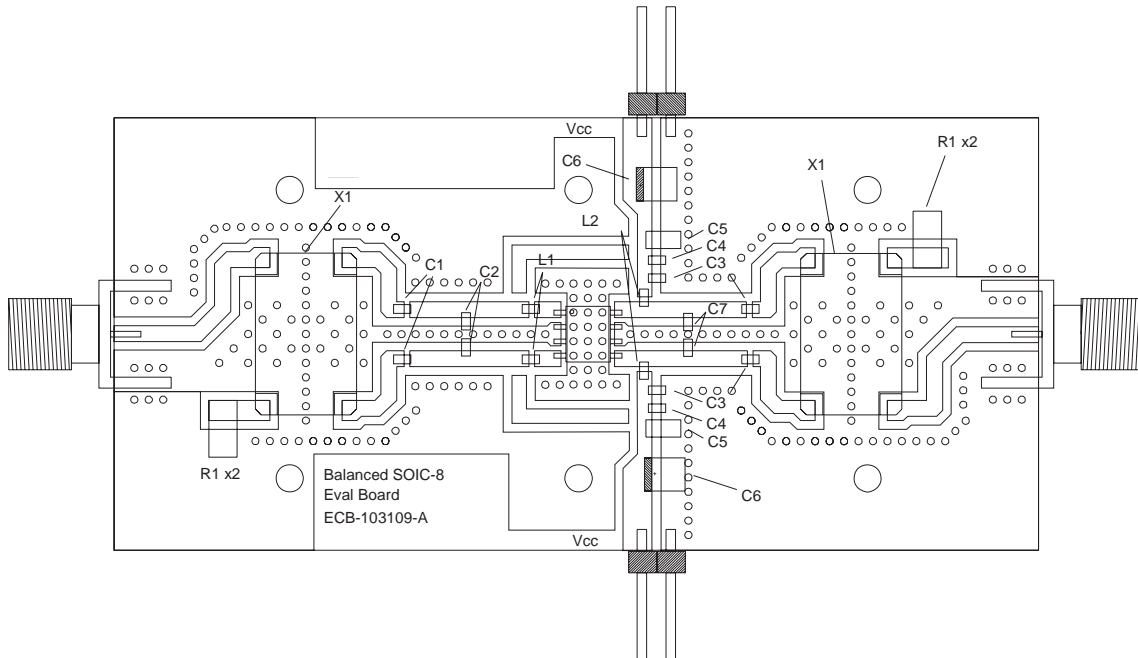

1960MHz and 2140MHz Application Schematic

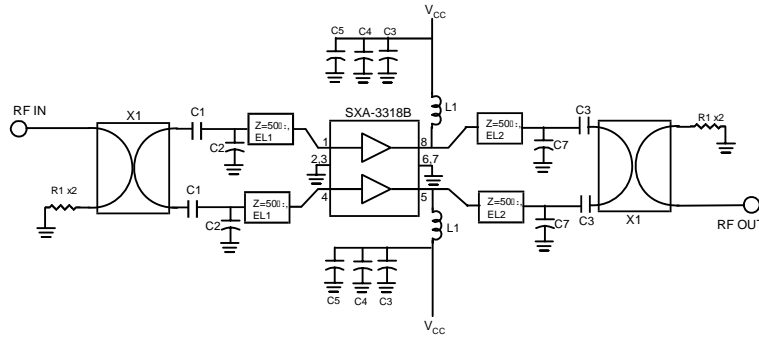

Ref. Des.	Vendor Series	1960 MHz	2140 MHz
C1, C3	Rohm MCH18	22pF, 5%	22pF, 5%
C2	Rohm MCH18	1.2pF, ± 0.25 pF	1.2pF, ± 0.25 pF
C4	Rohm MCH18	1000pF, 5%	1000pF, 5%
C5	Rohm TAJB104KLRH	0.1 μ F, 10%	0.1 μ F, 10%
C7	Rohm MCH18	1.0pF, ± 0.25 pF	1.0pF, ± 0.25 pF

Ref. Des.	Vendor Series	1960 MHz	2140 MHz
L1	Toko LL1608-FS	18nH, 5%	18nH, 5%
EL1	50 Ohms	10.1°	11°
EL2	50 Ohms	20.9°	22.8°
X1	Sirenza Coupler	AM03M	AM03M
R1	Rohm MCR100J	100 Ohm, 5%	100 Ohm, 5%

1960MHz and 2140MHz Evaluation Board Layout

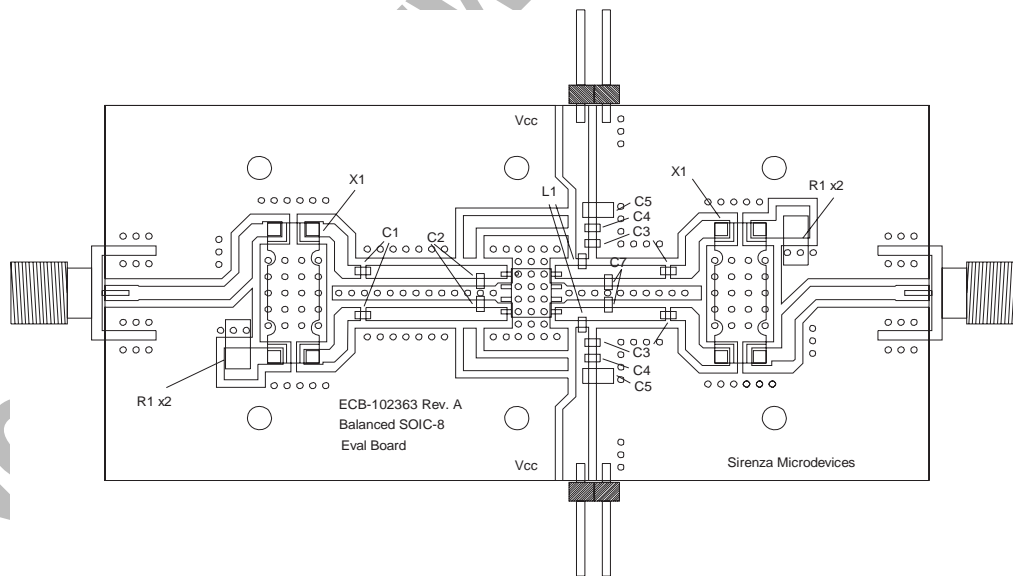

Part Symbolization

The part will be symbolized with a "SXA3318B" or "SXA3318BZ" designator on the top surface of the package.

Ordering Information

Part Number	Reel Size	Devices/Reel
SXA-3318B	7"	500
SXA-3318BZ	7"	500